

WGC-25-TB

WGC-25-TB, Transformador diferencial para Relé diferencial tipo B

Código: P11751.

- > Sección útil (mm): 25
- > $I_{\Delta n}$ mín.(A): 0.1
- > Corriente máx. (A): 63

Especificaciones

Alimentación en alterna (aislamiento)

Test de impulsos (kV)	3 kV
-----------------------	------

Características mecánicas

Tamaño (mm) ancho x alto x fondo	60.5 x 64 x 50 (mm)
Peso Neto (kg)	0,118

Precisión de medidas

Precisión	10 ... 15 %
-----------	-------------

WGC-TB

Transformador diferencial para relé tipo B

CÓDIGO	TIPO	Diámetro interior (mm)	In (A)
P11731.	WGS-20-TB	20	63
P11751.	WGC-25-TB	25	63
P11752.	WGC-35-TB	35	80
P11753.	WGC-55-TB	55	160
P11755.	WGC-80-TB	80	250
P11756.	WGC-110 TB	110	400
P11757.	WGC-140 TB	140	600
P11758.	WGC-180 TB	180	800



WGC-25-TB

Transformador diferencial para Relé diferencial tipo B

Código: P11751.

Dimensiones

WGC 25 / WGC 35

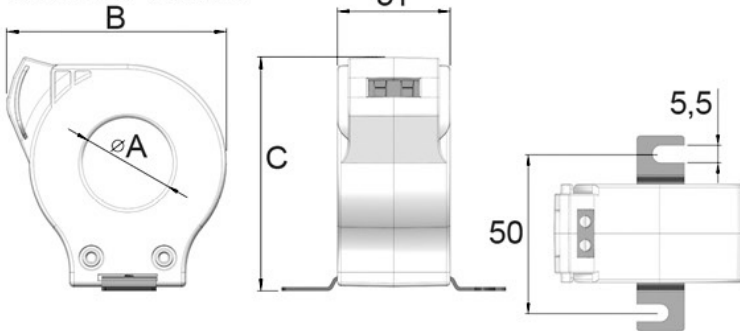

WGC 55 / WGC 80
WGC 110 / WGC 140

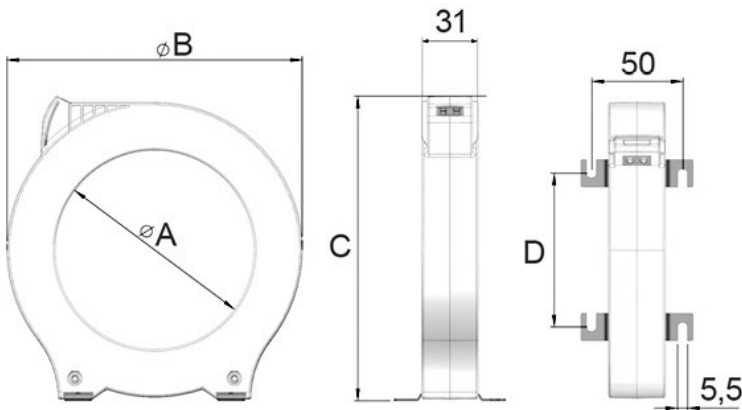

Modelo	A	B	C	D
WGC 25	25	60,5	64	
WGC 35	35	70,5	75,5	
WGC 55	55	92	98	38
WGC 80	80	124,5	130	60
WGC 110	110	163	168	84,5
WGC 140	140	201	206	110
WGC 180	180	252	256	144