



TRMC 210 -0.5S-3X600/5

TRMC 210 -0.5S-3X600/5, Transformateur de courant pour compteurs avec vérification en origine, primaire bobiné, classe 0,5S

Code: Q309870000001

- > Plat (mm): Primaire Bobiné
- > Classe 0,5S Puissance (VA): 2,5
- > Rang mesure (A): 600/5
- > Courant entrada: 600/5 A

Spécifications

Caractéristiques mécaniques

Taille (mm) larg. x haut. x prof.

145 x 110 x 86 (mm)

kit3-TRMC210.2

Transformateur de courant pour compteurs avec vérification en origine, primaire bobiné, classe 0,5S

CODE	TYPE
Q30981.	TRMC 210 -0.5S-3X100/5
Q30982.	TRMC 210 -0.5S-3X150/5
Q30983.	TRMC 210 -0.5S-3X200/5
Q30984.	TRMC 210 -0.5S-3X300/5
Q30985.	TRMC 210 -0.5S-3X400/5
Q30986.	TRMC 210 -0.5S-3X500/5
Q30987.	TRMC 210 -0.5S-3X600/5
Q3098D.	TRMC 210-3x50/5
Q309810000001	TRMC 210 -0.5S-3X100/5
Q309820000001	TRMC 210 -0.5S-3X150/5
Q309830000001	TRMC 210 -0.5S-3X200/5
Q309840000001	TRMC 210 -0.5S-3X300/5
Q309850000001	TRMC 210 -0.5S-3X400/5
Q309860000001	TRMC 210 -0.5S-3X500/5
Q309870000001	TRMC 210 -0.5S-3X600/5



TRMC 210 -0.5S-3X600/5

Code: Q309870000001

Dimensions

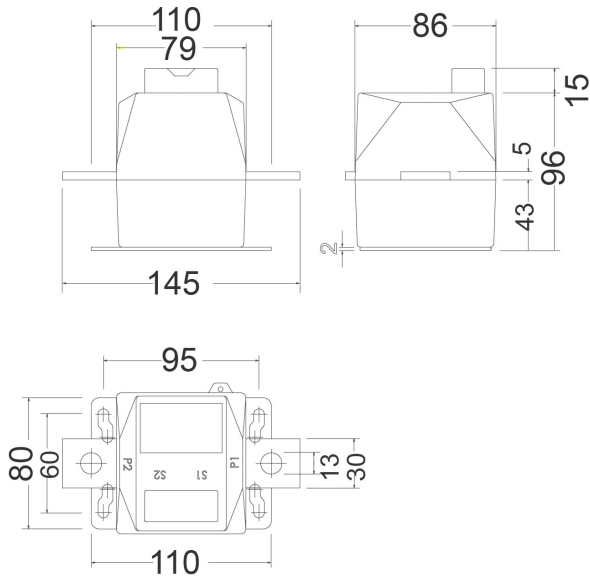

Connexions

