



## TRMC 210 -0.5-3X150/5

TRMC 210 -0.5-3X150/5, Transformateur de courant pour compteurs avec vérification en origine, primaire bobiné, classe 0,5

Code: Q30962.

- > Plat (mm): Primaire Bobiné
- > Classe 0,5 Puissance (VA): 10
- > Rang mesure (A): 150/5
- > Courant entrada: 150/5 A

## Spécifications

### Caractéristiques mécaniques

Taille (mm) larg. x haut. x prof.	145 x 110 x 86 (mm)
Poids (kg)	4,9

### kit3-TRMC210-05

Transformateur de courant pour compteurs avec vérification en origine, primaire bobiné, classe 0,5

CODE	TYPE
Q30961.	TRMC 210 -0.5-3X100/5
Q30962.	TRMC 210 -0.5-3X150/5
Q30963.	TRMC 210 -0.5-3X200/5
Q30964.	TRMC 210 -0.5-3X300/5
Q30965.	TRMC 210 -0.5-3X400/5
Q30966.	TRMC 210 -0.5-3X500/5
Q30967.	TRMC 210 -0.5-3X600/5
Q309610000001	TRMC 210 -0.5-3X100/5
Q309620000001	TRMC 210 -0.5-3X150/5
Q309630000001	TRMC 210 -0.5-3X200/5
Q309640000001	TRMC 210 -0.5-3X300/5
Q309650000001	TRMC 210 -0.5-3X400/5
Q309660000001	TRMC 210 -0.5-3X500/5
Q309670000001	TRMC 210 -0.5-3X600/5



## TRMC 210 -0.5-3X150/5

Code: Q30962.

### Dimensions

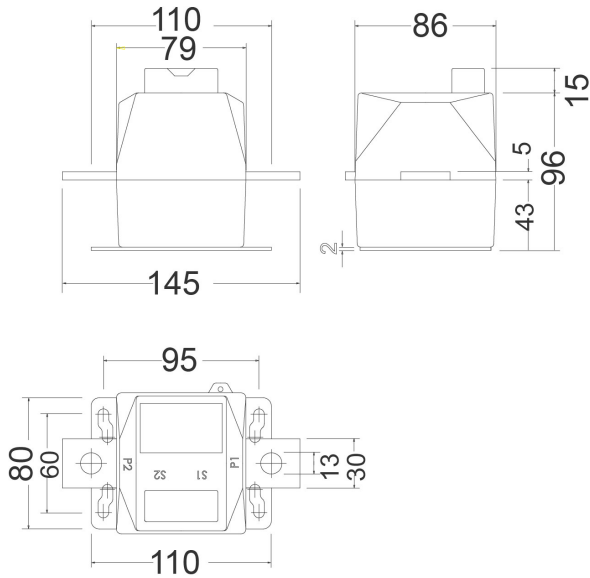

### Connexions

