



TRMC 210 -0.5S-3X100/5

TRMC 210 -0.5S-3X100/5, kit 3 Transformateurs de courant pour compteurs avec vérification en origine, primaire bobiné, classe 0,5S

Code: Q30901.

- > Plat (mm): Primaire Bobiné
- > Classe 0,5S Puissance (VA): 10
- > Rang mesure (A): 100/5
- > Courant entrada: 100/5 A

Spécifications

Caractéristiques mécaniques

Taille (mm) larg. x haut. x prof.	145 x 110 x 86 (mm)
Poids (kg)	5,1

kit3-TRMC210

kit 3 Transformateurs de courant pour compteurs avec vérification en origine, primaire bobiné

CODE	TYPE
Q30901.	TRMC 210 -0.5S-3X100/5
Q30902.	TRMC 210 -0.5S-3X150/5
Q30903.	TRMC 210 -0.5S-3X200/5
Q30904.	TRMC 210 -0.5S-3X300/5
Q30905.	TRMC 210 -0.5S-3X400/5
Q30906.	TRMC 210 -0.5S-3X500/5
Q30907.	TRMC 210 -0.5S-3X600/5
Q309010000001	TRMC 210 -0.5S-3X100/5
Q309020000001	TRMC 210 -0.5S-3X150/5
Q309030000001	TRMC 210 -0.5S-3X200/5
Q309040000001	TRMC 210 -0.5S-3X300/5
Q309050000001	TRMC 210 -0.5S-3X400/5
Q309060000001	TRMC 210 -0.5S-3X500/5
Q309070000001	TRMC 210 -0.5S-3X600/5

Consulter disponibilité.../1 A



TRMC 210 -0.5S-3X100/5

Code: Q30901.

Dimensions

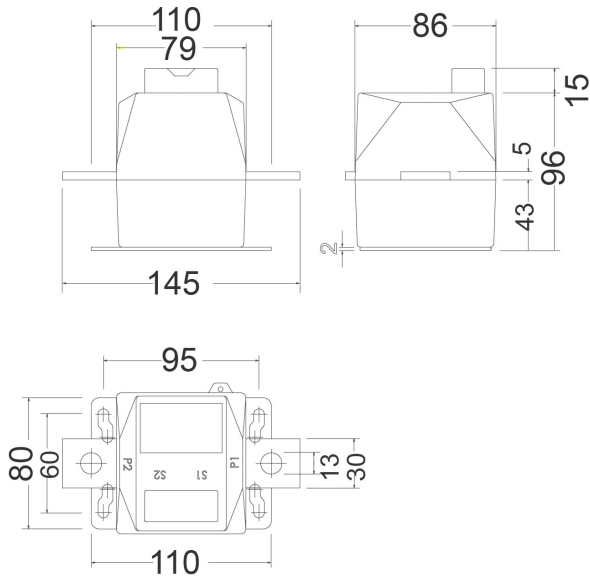

Connexions

