



CUC96 230V

CUC96 230V, Séquencemètres

Code: M13754.

- > N° relais: 1
- > Rang mesure (V): 230
- > Équipement: CUC96
- > Modules: 96x96

La description

A completely electronic circuit without moving parts allows easily activation of LED

Application

UC72 and **UC96** types indicate the phase sequence type in three-phase networks.

CUC96, besides indicating the phase sequence type, have a relay with a free voltage switch-over contact. The relay opens in voltage lack situation or when the phase rotation sense is wrong.



CUC96 230V

Code: M13754.

Spécifications

Caractéristiques mécaniques

Taille (mm) larg. x haut. x prof.	96 x 96 x 62.9 (mm)
Poids (kg)	0,38

Caractéristiques environnementales

Degré de protection	Panneau : IP 52 (avant), IP 00 (bornes)
Température de stockage	-40 ... +70 °C
Température de travail	0 ... +70 °C

Règlementation

Certifications	UL
Sécurité électrique, Altitude maximale (m)	2000
Règlementation	BS 89, UNE-EN 60051, IEC 144, UL94, DIN 43780, IEC 51, UNE 21318

Circuit de mesure de courant

Consommation	4 VA
Fréquence d'échantillonnage	50 Hz

Circuit de mesure de tension

Tension nominale	230 Vca (en option 100-120 Vca / 380-440 Vca)
Tension maximale de mesure permanente	1,2 Vn permanent rated voltage / 2 Vn during 5s

Précision de mesure

Précision	1,5 % FE
-----------	----------

UC / CUC

Séquencemètres

CODE	TYPE	Modules	Équipement
M13726.	UC72 100...150V	72x72	UC72
M13721.	UC72 150...500V	72x72	UC72
M13736.	UC96 100 ...150V	96x96	UC96
M13731.	UC96 150...500V	96x96	UC96
M13754.	CUC96 230V	96x96	CUC96
M13755.	CUC96 400V	96x96	CUC96



CUC96 230V

Code: M13754.

Dimensions

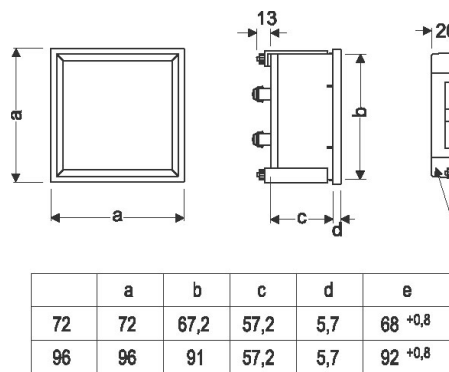

Connexions

