



COFRET-VE8-2P-40A MID

COFRET-VE8-2P-40A MID, Protection box

Code: V41263. DESCATALOGADO

- > Módulos: 8
- > Poles: 2
- > Energy meter: MID
- > Surge Protection (SPD): No
- > System: Single-phase
- > In (A): 40
- > Key: 1
- > Earth leakage protection: Type A
- > Circuit breaker protection: 40 A

Description

COFRET boxes are designed to offer electrical protection in compliance with the **ITC-BT-52** standard for infrastructures designed to charge electric vehicles. The devices have a Type A RCCB for direct or indirect exposure protection, and a C-curve circuit breaker to protect the recharging units in the event of overloads or short-circuits. If the installation does not have overvoltage protection, a model is available that includes both permanent and transient surge protection.

Application

The COFRET box is absolutely essential when installing any single-phase electric vehicle charging point.



COFRET-VE8-2P-40A MID

Protection box for single-phase charging points

Code: V41263.

Specifications

Mechanical characteristics

Size (mm) width x height x depth	215 x 200 x 115 (mm)
Weight (kg)	1,7

COFRET

Protection box for charging points

CODE	TYPE	Earth leakage protection	Circuit breaker protection	Surge Protection (SPD)	Módulos	Poles	Energy meter	Surge Protection (SPD+POP)
2 poles								
V41231.	COFRET-VE6-2P-20A	Type A	20 A	No	6	2	-	
V41232.	COFRET-VE6-2P-20AS	Type A	20 A	Yes	6	2	-	
V4123Q.	COFRET-VE8-2P-20AS 6DC	Type A + 6 mADC	20 A	Yes	8	2	-	
V41261.	COFRET-VE6-2P-40A	Type A	40 A	No	6	2	-	
V41262.	COFRET-VE6-2P-40AS	Type A	40 A	Yes	6	2	-	
2 poles - Meter reconnection scheme 2								
V4126X.	COFRET-VE8-2P-40AS REC	Type A	40 A		8	2	-	Yes
2 poles								
V41266.	COFRET-VE8-2P-40AS-MID	Type A	40 A	Yes	8	2	MID	
4 poles								
V41461.	COFRET-VE12-4P-40A	Type A	40 A	No	12	4	-	
V41462.	COFRET-VE12-4P-40AS	Type A	40 A	Yes	12	4	-	

Electrical protections in accordance with ITC-BT-52 standard, Circuit breaker protection with C curve, 30 mA differential protection, Key closure, Polycarbonate and polystyrene enclosure - IP 65 - IK08.



COFRET-VE8-2P-40A MID

Protection box for single-phase charging points

Code: V41263.

Dimensions

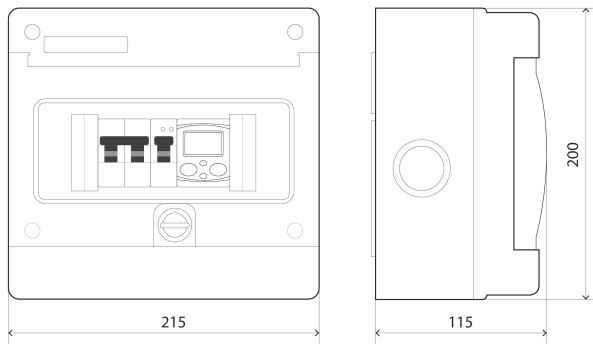

Connections

