



TRMC 210 -0.5S-3X300/5

TRMC 210 -0.5S-3X300/5, set of 3 current transformers for energy meters, class 0,5S

Code: Q30984.

- > Class 0,5S Power (VA): 2,5
- > Measurement Range (A): 300/5
- > Input current: 300/5 A

Specifications

Mechanical characteristics

Size (mm) width x height x depth	145 x 110 x 86 (mm)
Weight (kg)	4,2

kit3-TRMC210.2

Sets of 3 current transformers for energy meters class 0,5S

CODE	TYPE
Q30981.	TRMC 210 -0.5S-3X100/5
Q30982.	TRMC 210 -0.5S-3X150/5
Q30983.	TRMC 210 -0.5S-3X200/5
Q30984.	TRMC 210 -0.5S-3X300/5
Q30985.	TRMC 210 -0.5S-3X400/5
Q30986.	TRMC 210 -0.5S-3X500/5
Q30987.	TRMC 210 -0.5S-3X600/5
Q3098D.	TRMC 210-3x50/5
Q309810000001	TRMC 210 -0.5S-3X100/5
Q309820000001	TRMC 210 -0.5S-3X150/5
Q309830000001	TRMC 210 -0.5S-3X200/5
Q309840000001	TRMC 210 -0.5S-3X300/5
Q309850000001	TRMC 210 -0.5S-3X400/5
Q309860000001	TRMC 210 -0.5S-3X500/5
Q309870000001	TRMC 210 -0.5S-3X600/5



TRMC 210 -0.5S-3X300/5

Code: Q30984.

Dimensions

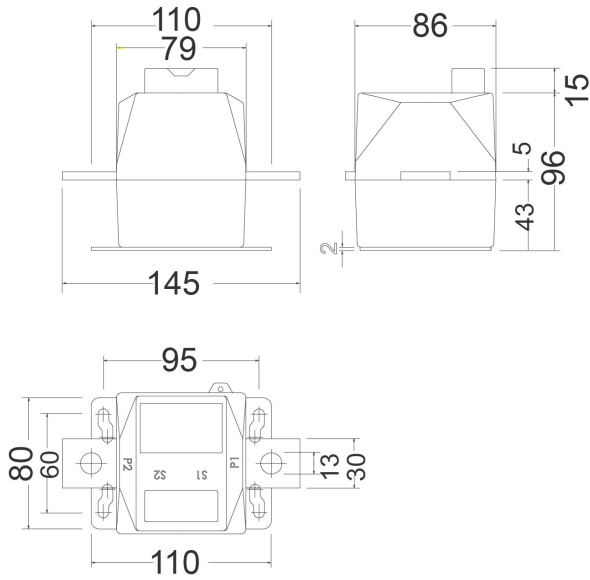

Connections

