

TRMC 210 -0.5-3X400/5

TRMC 210 -0.5-3X400/5, set of 3 current transformers for energy meters, class 0,5S

Code: Q30965.

- > Class 0,5 Power (VA): 10
- > Measurement Range (A): 400/5
- > Input current: 400/5 A

Specifications

Mechanical characteristics

Size (mm) width x height x depth	145 x 110 x 86 (mm)
Weight (kg)	4,5

kit3-TRMC210-05

Sets of 3 current transformers for energy meters class 0,5

CODE	TYPE
Q30961.	TRMC 210 -0.5-3X100/5
Q30962.	TRMC 210 -0.5-3X150/5
Q30963.	TRMC 210 -0.5-3X200/5
Q30964.	TRMC 210 -0.5-3X300/5
Q30965.	TRMC 210 -0.5-3X400/5
Q30966.	TRMC 210 -0.5-3X500/5
Q30967.	TRMC 210 -0.5-3X600/5
Q309610000001	TRMC 210 -0.5-3X100/5
Q309620000001	TRMC 210 -0.5-3X150/5
Q309630000001	TRMC 210 -0.5-3X200/5
Q309640000001	TRMC 210 -0.5-3X300/5
Q309650000001	TRMC 210 -0.5-3X400/5
Q309660000001	TRMC 210 -0.5-3X500/5
Q309670000001	TRMC 210 -0.5-3X600/5



TRMC 210 -0.5-3X400/5

Code: Q30965.

Dimensions

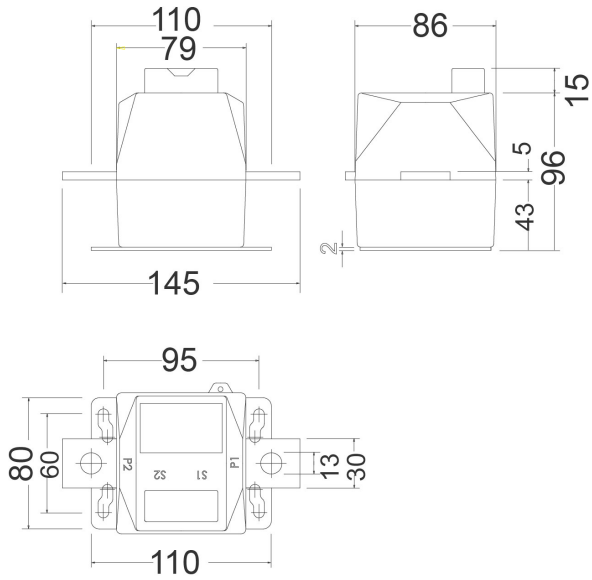

Connections

