



TRMC-X3 200/5 Ext

TRMC-X3 200/5 Ext, Current transformers

Code: Q301T2010E000

- > Usefull diam.(mm): 38
- > Cable (m): 6
- > Class 0,5S Power (VA): 2,5
- > Measurement Range (A): 200/5

Specifications

AC power supply

Frequency	50 / 60 Hz
-----------	------------

Electrical characteristics

Safety factor (SF)	5
Power	2,5 ... 5 VA
Insulation voltage, circuit	3 kV

Mechanical characteristics

Size (mm) width x height x depth	245 x 80 x 98.5 (mm)
Envelope	Self-extinguishing V0 plastic, filled with synthetic resin
Weight (kg)	2,9

Environmental characteristics

Thermal Class	class B (+130 °C)
Relative humidity (without condensation)	5 ... 95 %
Installation, location, position.	Inside
Storage temperature	-15 ... +50 °C
Working temperature	-5 ... +40 °C

Specific technical characteristics of current sensors

Operating voltage	0,72 kV~ máx.
-------------------	---------------

Standards

Certifications	UL 94
Electrical safety, Maximum height (m)	1000
Standards	IEC 61869-2, IEC 60038, IEC 60071-1, IEC 60071-2, IEC 60721-3-3, IEC 60085, EN 60076-5, UNE 21-305-90, UNE-EN 60695-2-10, UNE-EN 60695-2-11, UL 94

Current measurement circuit

Primary current measurement	200 A
Dynamic current (Idyn)	2,5 Ith
Thermal short-circuit current (Ith)	60 In
Transformation ratio	... / 5 A



TRMC-X3 200/5 Ext

Code: Q301T2010E000

TRMCx3

Three-phase current transformers for energy meters

CODE	TYPE	Measurement Range (A)	Class 0,5S Power (VA)	Inner diameter (mm)	Cable (m)
Outdoor					
Q301T1010E000	TRMC-X3 100/5 Ext	100/5	2,5	38	6
Q301T2010E000	TRMC-X3 200/5 Ext	200/5	2,5	38	6
Q301T3010E000	TRMC-X3 300/5-Ext	300/5	2,5	38	6
Q301T4010E000	TRMC-X3 400/5 Ext	400/5	2,5	38	6



TRMC-X3 200/5 Ext

Code: Q301T2010E000

Dimensions

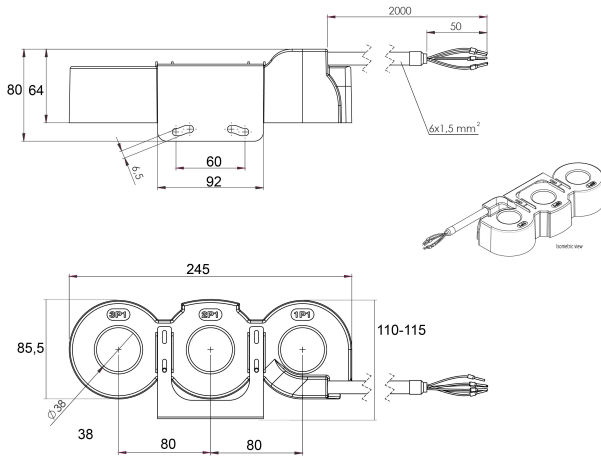

Connections

