



## TRM80 2000/5A

---

TRM80 2000/5A, Measuring transformers encapsulated in resin

Code: P50136.

- > Inner diameter (mm): 80
- > System: Single-phase
- > Class 0,5 Power (VA): 25
- > Measurement Range (A): 2000/5
- > Input current: 2000 A
- > Transformer type: Encapsulated in resin

### Description

---

Resin-coated current transformer, busbar. Other characteristics:

- From 75 to 5000 A
- Inner diameter from 30 to 180 mm, according to type
- Secondary .../5 A ( .../1 A on request)

### Application

---

These transformers have been conceived to convert nominal currents in any installation to current values adjusted to measurement devices. Its synthetic resin increases its resistance to adverse environmental conditions.

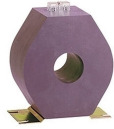

## TRM80 2000/5A

Measuring transformers encapsulated in resin

Code: P50136.

### Specifications

#### Electrical characteristics

|  |                   |
|--|-------------------|
| Power                                      | 25 VA (Class 0,5) |
| Insulation voltage between terminals S1-S2 | 3 kV              |

#### Mechanical characteristics

|                                  |  |
|----------------------------------|--|
| Size (mm) width x height x depth | 135 x 178 x 36 (mm)                    |
| Envelope                         | Self-extinguishing V0, synthetic resin |
| Weight (kg)                      | 1                                      |

#### Environmental characteristics

|               |                   |
|---------------|-------------------|
| Thermal Class | Class B (+130 °C) |
|---------------|-------------------|

#### Specific technical characteristics of current sensors

|                       |               |
|-----------------------|---------------|
| Inner diameter Ø (mm) | 80            |
| Operating voltage     | 0,72 kV~ max. |

#### Current measurement circuit

|                                     |            |
|-------------------------------------|------------|
| Nominal frequency                   | 50 / 60 Hz |
| Primary current measurement         | 2000 A     |
| Dynamic current (Idyn)              | 2,5 Ith    |
| Thermal short-circuit current (Ith) | 60 In      |
| Transformation ratio                | ... / 5 A  |

#### Standards

|           |                              |
|-----------|------------------------------|
| Standards | IEC 60044-1 / UNE EN 60044-1 |
|-----------|------------------------------|

#### TRM

Measuring transformers encapsulated in resin

| CODE         | TYPE         | Measurement Range (A) | Inner diameter (mm) | Class 0,5 Power (VA) | Class 1 Power (VA) |
|--------------|--------------|-----------------------|---------------------|----------------------|--------------------|
| <b>TRM30</b> |              |                       |                     |                      |                    |
| P50101.      | TRM30 75/5A  | 75/5                  | 30                  | -                    | 2                  |
| P50102.      | TRM30 100/5A | 100/5                 | 30                  | -                    | 5                  |
| P50103.      | TRM30 150/5A | 150/5                 | 30                  | -                    | 5                  |
| P50104.      | TRM30 200/5A | 200/5                 | 30                  | 10                   | -                  |
| P50105.      | TRM30 250/5A | 250/5                 | 30                  | 15                   | -                  |
| P50106.      | TRM30 300/5A | 300/5                 | 30                  | 20                   | -                  |



## TRM80 2000/5A

Measuring transformers encapsulated in resin

Code: P50136.

| CODE          | TYPE           | Measurement Range (A) | Inner diameter (mm) | Class 0,5 Power (VA) | Class 1 Power (VA) |
|---------------|----------------|-----------------------|---------------------|----------------------|--------------------|
| P50107.       | TRM30 400/5A   | 400/5                 | 30                  | 25                   | -                  |
| <b>TRM40</b>  |                |                       |                     |                      |                    |
| P50111.       | TRM40 150/5A   | 150/5                 | 40                  | 5                    | -                  |
| P50112.       | TRM40 200/5A   | 200/5                 | 40                  | 7,5                  | -                  |
| P50113.       | TRM40 250/5A   | 250/5                 | 40                  | 10                   | -                  |
| P50114.       | TRM40 300/5A   | 300/5                 | 40                  | 15                   | -                  |
| P50115.       | TRM40 400/5A   | 400/5                 | 40                  | 20                   | -                  |
| P50116.       | TRM40 500/5A   | 500/5                 | 40                  | 25                   | -                  |
| P50117.       | TRM40 600/5A   | 600/5                 | 40                  | 30                   | -                  |
| P50118.       | TRM40 800/5A   | 800/5                 | 40                  | 35                   | -                  |
| <b>TRM60</b>  |                |                       |                     |                      |                    |
| P50121.       | TRM60 250/5A   | 250/5                 | 60                  | 5                    | -                  |
| P50122.       | TRM60 300/5A   | 300/5                 | 60                  | 7,5                  | -                  |
| P50123.       | TRM60 400/5A   | 400/5                 | 60                  | 10                   | -                  |
| P50124.       | TRM60 500/5A   | 500/5                 | 60                  | 15                   | -                  |
| P50125.       | TRM60 600/5A   | 600/5                 | 60                  | 20                   | -                  |
| P50126.       | TRM60 800/5A   | 800/5                 | 60                  | 25                   | -                  |
| P50127.       | TRM60 1000/5A  | 1000/5                | 60                  | 30                   | -                  |
| P50128.       | TRM60 1200/5A  | 1200/5                | 60                  | 35                   | -                  |
| <b>TRM80</b>  |                |                       |                     |                      |                    |
| P50131.       | TRM80 500/5A   | 500/5                 | 80                  | 5                    | -                  |
| P50132.       | TRM80 600/5A   | 600/5                 | 80                  | 7,5                  | -                  |
| P50133.       | TRM80 750/5A   | 750/5                 | 80                  | 10                   | -                  |
| P50134.       | TRM80 1000/5A  | 1000/5                | 80                  | 15                   | -                  |
| P50135.       | TRM80 1500/5A  | 1500/5                | 80                  | 20                   | -                  |
| P50136.       | TRM80 2000/5A  | 2000/5                | 80                  | 25                   | -                  |
| P50137.       | TRM80 2500/5A  | 2500/5                | 80                  | 30                   | -                  |
| <b>TRM100</b> |                |                       |                     |                      |                    |
| P50141.       | TRM100 750/5A  | 750/5                 | 100                 | 15                   | -                  |
| P50142.       | TRM100 1000/5A | 1000/5                | 100                 | 20                   | -                  |
| P50144.       | TRM100 1500/5A | 1500/5                | 100                 | 20                   | -                  |
| P50145.       | TRM100 2000/5A | 2000/5                | 100                 | 20                   | -                  |
| P50146.       | TRM100 2500/5A | 2500/5                | 100                 | 20                   | -                  |
| P50147.       | TRM100 3000/5A | 3000/5                | 100                 | 25                   | -                  |
| <b>TRM140</b> |                |                       |                     |                      |                    |
| P50151.       | TRM140 1000/5A | 1000/5                | 140                 | 15                   | -                  |
| P50152.       | TRM140 1250/5A | 1250/5                | 140                 | 20                   | -                  |
| P50153.       | TRM140 1500/5A | 1500/5                | 140                 | 25                   | -                  |



## TRM80 2000/5A

Measuring transformers encapsulated in resin

Code: P50136.

| CODE          | TYPE           | Measurement Range (A) | Inner diameter (mm) | Class 0,5 Power (VA) | Class 1 Power (VA) |
|---------------|----------------|-----------------------|---------------------|----------------------|--------------------|
| P50154.       | TRM140 2000/5A | 2000/5                | 140                 | 30                   | -                  |
| P50155.       | TRM140 2500/5A | 2500/5                | 140                 | 35                   | -                  |
| P50156.       | TRM140 3000/5A | 3000/5                | 140                 | 35                   | -                  |
| P50157.       | TRM140 4000/5A | 4000/5                | 140                 | 35                   | -                  |
| <b>TRM180</b> |                |                       |                     |                      |                    |
| P50161.       | TRM180 1250/5A | 1250/5                | 180                 | 15                   | -                  |
| P50162.       | TRM180 1500/5A | 1500/5                | 180                 | 20                   | -                  |
| P50163.       | TRM180 2000/5A | 2000/5                | 180                 | 20                   | -                  |
| P50164.       | TRM180 2500/5A | 2500/5                | 180                 | 20                   | -                  |
| P50165.       | TRM180 3000/5A | 3000/5                | 180                 | 20                   | -                  |
| P50166.       | TRM180 4000/5A | 4000/5                | 180                 | 20                   | -                  |
| P50167.       | TRM180 5000/5A | 5000/5                | 180                 | 20                   | -                  |

For other configurations see table of additional features



## TRM80 2000/5A

---

Measuring transformers encapsulated in resin

Code: P50136.

## Dimensions

---

