



## TRM60 500/5A

---

TRM60 500/5A, Measuring transformers encapsulated in resin

Code: P50124.

- > Inner diameter (mm): 60
- > System: Single-phase
- > Class 0,5 Power (VA): 15
- > Measurement Range (A): 500/5
- > Input current: 500 A
- > Transformer type: Encapsulated in resin

### Description

---

Resin-coated current transformer, busbar. Other characteristics:

- From 75 to 5000 A
- Inner diameter from 30 to 180 mm, according to type
- Secondary .../5 A ( .../1 A on request)

### Application

---

These transformers have been conceived to convert nominal currents in any installation to current values adjusted to measurement devices. Its synthetic resin increases its resistance to adverse environmental conditions.



## TRM60 500/5A

Measuring transformers encapsulated in resin

Code: P50124.

### Specifications

#### Electrical characteristics

Power	15 VA (Class 0,5)
Insulation voltage between terminals S1-S2	3 kV

#### Mechanical characteristics

Size (mm) width x height x depth	135 x 178 x 36 (mm)
Envelope	Self-extinguishing V0, synthetic resin
Weight (kg)	1,3

#### Environmental characteristics

Thermal Class	Class B (+130 °C)
---------------	-------------------

#### Specific technical characteristics of current sensors

Inner diameter Ø (mm)	60
Operating voltage	0,72 kV~ max.

#### Current measurement circuit

Nominal frequency	50 / 60 Hz
Primary current measurement	500 A
Dynamic current (I <sub>dyn</sub> )	2,5 I <sub>th</sub>
Thermal short-circuit current (I <sub>th</sub> )	60 I <sub>n</sub>
Transformation ratio	... / 5 A

#### Standards

Standards	IEC 60044-1 / UNE EN 60044-1
-----------	------------------------------

#### TRM

Measuring transformers encapsulated in resin

CODE	TYPE	Measurement Range (A)	Inner diameter (mm)	Class 0,5 Power (VA)	Class 1 Power (VA)
<b>TRM30</b>					
P50101.	TRM30 75/5A	75/5	30	-	2
P50102.	TRM30 100/5A	100/5	30	-	5
P50103.	TRM30 150/5A	150/5	30	-	5
P50104.	TRM30 200/5A	200/5	30	10	-
P50105.	TRM30 250/5A	250/5	30	15	-
P50106.	TRM30 300/5A	300/5	30	20	-



## TRM60 500/5A

Measuring transformers encapsulated in resin

Code: P50124.

CODE	TYPE	Measurement Range (A)	Inner diameter (mm)	Class 0,5 Power (VA)	Class 1 Power (VA)
P50107.	TRM30 400/5A	400/5	30	25	-
<b>TRM40</b>					
P50111.	TRM40 150/5A	150/5	40	5	-
P50112.	TRM40 200/5A	200/5	40	7,5	-
P50113.	TRM40 250/5A	250/5	40	10	-
P50114.	TRM40 300/5A	300/5	40	15	-
P50115.	TRM40 400/5A	400/5	40	20	-
P50116.	TRM40 500/5A	500/5	40	25	-
P50117.	TRM40 600/5A	600/5	40	30	-
P50118.	TRM40 800/5A	800/5	40	35	-
<b>TRM60</b>					
P50121.	TRM60 250/5A	250/5	60	5	-
P50122.	TRM60 300/5A	300/5	60	7,5	-
P50123.	TRM60 400/5A	400/5	60	10	-
P50124.	TRM60 500/5A	500/5	60	15	-
P50125.	TRM60 600/5A	600/5	60	20	-
P50126.	TRM60 800/5A	800/5	60	25	-
P50127.	TRM60 1000/5A	1000/5	60	30	-
P50128.	TRM60 1200/5A	1200/5	60	35	-
<b>TRM80</b>					
P50131.	TRM80 500/5A	500/5	80	5	-
P50132.	TRM80 600/5A	600/5	80	7,5	-
P50133.	TRM80 750/5A	750/5	80	10	-
P50134.	TRM80 1000/5A	1000/5	80	15	-
P50135.	TRM80 1500/5A	1500/5	80	20	-
P50136.	TRM80 2000/5A	2000/5	80	25	-
P50137.	TRM80 2500/5A	2500/5	80	30	-
<b>TRM100</b>					
P50141.	TRM100 750/5A	750/5	100	15	-
P50142.	TRM100 1000/5A	1000/5	100	20	-
P50144.	TRM100 1500/5A	1500/5	100	20	-
P50145.	TRM100 2000/5A	2000/5	100	20	-
P50146.	TRM100 2500/5A	2500/5	100	20	-
P50147.	TRM100 3000/5A	3000/5	100	25	-
<b>TRM140</b>					
P50151.	TRM140 1000/5A	1000/5	140	15	-
P50152.	TRM140 1250/5A	1250/5	140	20	-
P50153.	TRM140 1500/5A	1500/5	140	25	-



## TRM60 500/5A

Measuring transformers encapsulated in resin

Code: P50124.

CODE	TYPE	Measurement Range (A)	Inner diameter (mm)	Class 0,5 Power (VA)	Class 1 Power (VA)
P50154.	TRM140 2000/5A	2000/5	140	30	-
P50155.	TRM140 2500/5A	2500/5	140	35	-
P50156.	TRM140 3000/5A	3000/5	140	35	-
P50157.	TRM140 4000/5A	4000/5	140	35	-
<b>TRM180</b>					
P50161.	TRM180 1250/5A	1250/5	180	15	-
P50162.	TRM180 1500/5A	1500/5	180	20	-
P50163.	TRM180 2000/5A	2000/5	180	20	-
P50164.	TRM180 2500/5A	2500/5	180	20	-
P50165.	TRM180 3000/5A	3000/5	180	20	-
P50166.	TRM180 4000/5A	4000/5	180	20	-
P50167.	TRM180 5000/5A	5000/5	180	20	-

For other configurations see table of additional features



## TRM60 500/5A

Measuring transformers encapsulated in resin

Code: P50124.

### Dimensions

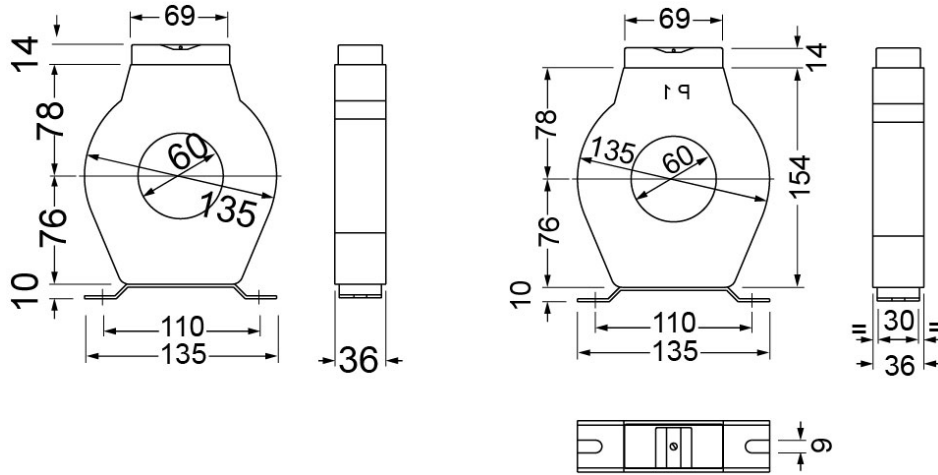

TRM 60