

RGMD-4-40-30

RGMD-4-40-30, Residual current relay

Code: P13471. DESCATALOGADO

- > Poles: 4
- > In (A): 40 A
- > Sensitivity: 30 mA
- > Mounting: DIN rail

Description

Ultraimmunised residual current and circuit breaker protection device. Compact solution mounted on DIN rails, used to prevent unwanted tripping in electrical installations. Electronic residual current protection at 30 or 300 mA guarantees a high degree of immunity and displays the presence of voltage on the electric panel with LEDs.

- Easy cabling of the system's elements.
- Used in single and three-phase installations of up to 63 A.

Application

All electrical installations where process continuity is critical and protection of persons (30 mA) and machines (300 mA) is required, with non-adjustable immediate activation.

- Computer systems (UPS systems)
- Air-conditioning/cooling systems
- Lifts/Service lifts
- Alarm Systems



RGMD-4-40-30

Ultraimmunised Earth Leakage Circuit Breaker

Code: P13471.

Specifications

AC power supply

Frequency	50/60 Hz
Nominal voltage	230 V ~ ($\pm 20\%$)

Mechanical characteristics

Size (mm) width x height x depth	105 x 91.6 x 72 (mm)
Fastening	DIN 46277 (EN 50022)
Weight (kg)	0,67

Environmental characteristics

Protection class	IP 20 (terminals), IP 41 (rear panel)
Working temperature	-10 ... +55 °C

Coil characteristics

Nominal control voltage (Uc)	230 V ~
------------------------------	---------

External reset input for tripping

Type	Voltage free
------	--------------

Standards

Standards	IEC 60947-2-M, IEC 60898, IEC 61008-1, IEC 60755
-----------	--

Digital relay outputs

Nominal current	5 A
Nominal voltage	230 V ~

Differential protection

Type	Type A ultra-immunised
Sensitivity ($I_{\Delta n}$), A	0,03
Delay time (t_{Δ})	Instantaneous or General (IEC 61008-1)
Transformer	External, WGC / WGS series

Protection

LED indication	Voltage presence Earth leakage tripping Sensor disconnection
Measure	True root mean square (TRMS)
Circuit breaker type	Built-in circuit breaker and component: RG1M earth leakage relay

Thermal-magnetic protection

Trip curve, Type	C (otras consultar)
------------------	---------------------

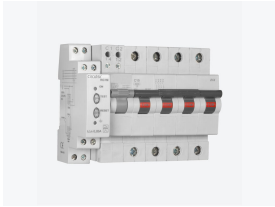

RGMD-4-40-30

Ultraimmunised Earth Leakage Circuit Breaker

Code: P13471.

Nominal current I_n (A)	40
Breaking capacity	6 kA (EN 60898), (consult others)
Nominal voltage	240 V ~ / 415 VA ~

It features an RGIM residual current relay, WGS/WGC residual current transformer and C curve circuit breaker, 6 kA (IEC 60898) with 230 Vac trigger coil. Curve 10 kA (IEC 60947-2) check

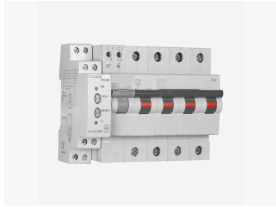

RGMD-4-40-30

Ultraimmunised Earth Leakage Circuit Breaker

Code: P13471.

Dimensions

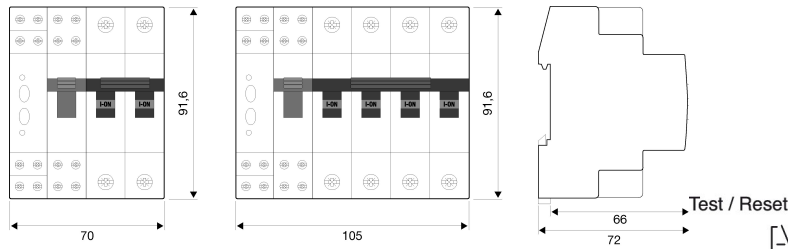

Connections

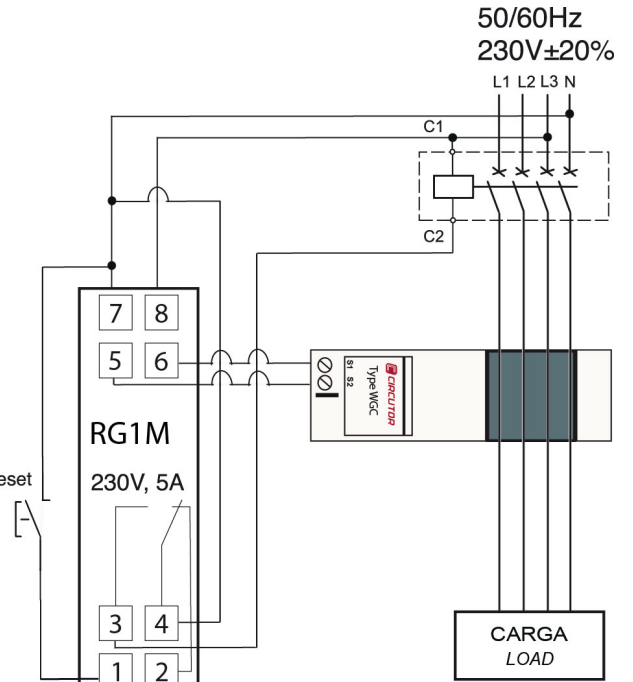

Disparo por BOBINA DE EMISIÓN
 - Rearme manual.
 Trip by SHUNT COIL.
 - Manual reclose.