



## STQ-24 250/1A

STQ-24 250/1A, Split core current transformer

Code: M737190010000

- > System: Single-phase
- > Class 1 Power (VA): 1
- > Measurement Range (A): 250/1
- > Input current: 250 A
- > Transformer type: Split core

### Description

Open-core current transformers with compact dimensions for easy installation. This type of transformer is very easy to install and uninstall on compact panels where the reduced space makes it difficult to take current measurements. In addition, their open-core design means that they can take measurements without having to interrupt the electric supply. The primary current measurement range is from 100 A to 300 A using different secondary outputs (.../1A, .../5A or .../250mA) with a maximum admissible cable diameter of 24 mm.

### Application

Quick and easy assembly are a fundamental aspect when taking temporary measurements in an electrical installation. **STQ-24** transformers can take energy measurements together with **CIRCUITOR**'s power analyzers or energy meters (**CVM-MINI**, **CVM-NET**, **CVM-C**, **CVM-B**, **EDMk**, etc.) without having to interrupt the electric supply. The open-core design of the transformer makes it very easy to install and allows installers to take electrical measurements in less time.



## STQ-24 250/1A

Split-core current Transformers

Code: M737190010000

### Specifications

#### Electrical characteristics

Safety factor (SF)	5
Power	1 VA (class 1)
Insulation voltage between terminals S1-S2	3 kV

#### Mechanical characteristics

Size (mm) width x height x depth	53 x 70 x 43.2 (mm)
Envelope	PC Lexan™ 940-701
Weight (kg)	0,262

#### Environmental characteristics

Thermal Class	Class B (+130 °C)
Protection class	IP 20
Relative humidity (without condensation)	15 ... 85%
Storage temperature	-20 ... 75 °C
Working temperature	-5 ... +40 °C

#### Specific technical characteristics of current sensors

Inner diameter Ø (mm)	24
Operating voltage	0,72 kV~ máx.

#### Current measurement circuit

Nominal frequency	50 / 60 Hz
Primary current measurement	250 A
Allowable overload	1,2 I <sub>n</sub>
Dynamic current (I <sub>dyn</sub> )	2,5 I <sub>th</sub>
Thermal short-circuit current (I <sub>th</sub> )	60 I <sub>n</sub>
Transformation ratio	... / 1 A

#### Standards

Electrical safety, Maximum height (m)	1000
Standards	UNE-EN 61869-1, UNE-EN 61869-2

#### Measurement accuracy

Accuracy	Clase 1/3
----------	-----------

STQ

Current transformers, split core



## STQ-24 250/1A

Split-core current Transformers

Code: M737190010000

CODE	TYPE	Measurement Range (A)	Class 1 Power (VA)	Class 3 Power (VA)
<b>5A</b>				
M73715.	STQ-24 100/5A	100/5	-	1
M73717.	STQ-24 150/5A	150/5	-	1
M73718.	STQ-24 200/5A	200/5	-	1
M73719.	STQ-24 250/5A	250/5	1	-
M7371A.	STQ-24 300/5A	300/5	1	-
<b>1A</b>				
M737150010000	STQ-24 100/1A	100/1	-	1
M737170010000	STQ-24 150/1A	150/1	-	1
M737180010000	STQ-24 200/1A	200/1	-	1
M737190010000	STQ-24 250/1A	250/1	1	-
M7371A0010000	STQ-24 300/1A	300/1	1	-
<b>250mA</b>				
M7371200A0000	STQ-24 50/250 mA	50/250 mA	-	0,1
M7371500A0000	STQ-24 100/250 mA	100/250 mA	-	0,1
M7371700A0000	STQ-24 150/250 mA	150/250 mA	-	0,1
M7371800A0000	STQ-24 200/250 mA	200/250 mA	-	0,1
M7371900A0000	STQ-24 250/250 mA	250/250 mA	0,1	-
M7371A00A0000	STQ-24 300/250 mA	300/250 mA	0,1	-



# STQ-24 250/1A

Split-core current Transformers

Code: M737190010000

## Dimensions

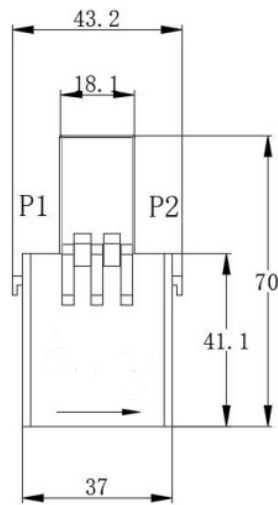
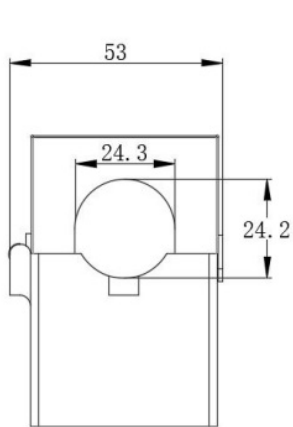

## Connections

Equipo de medida / Measuring device

