



TSR-3

TSR-3, Adding Transformer

Code: M70702.

- > Measuring Channels: 3
- > Class 0,5 Power (VA): 15
- > Class 1 Power (VA): 30
- > Input current: 5 A
- > Transformer type: Adding Transformer

Description

- Accuracy class 0,5
- Power 15 V-A
- The transformers added must have the same ratio
- No input must be without a connection

Application

Used to add the current to various AC electrical lines to obtain a common output current that is proportional to the sum of all currents. The current of various lines can be measured in a single unit.



TSR-3

Current adding transformers fixed on a DIN rail

Code: M70702.

Specifications

Mechanical characteristics

Size (mm) width x height x depth	110 x 72.5 x 110 (mm)
Weight (kg)	1,006

TSR

Current adding transformer

CODE	TYPE	Measurement Range (A)	Class 0,5 Power (VA)	Class 1 Power (VA)	Class 3 Power (VA)
M70701.	TSR-2	5 A	15	30	-
M70702.	TSR-3	5 A	15	30	-
M70703.	TSR-4	5 A	15	30	-
M70704.	TSR-5	5 A	15	30	-

Current adding transformers must have the same primary ratio.

For three-phase networks, one transformer per phase is required.

It is fed from the same measure.

For other ratios, please ask.



TSR-3

Current adding transformers fixed on a DIN rail

Code: M70702.

Dimensions

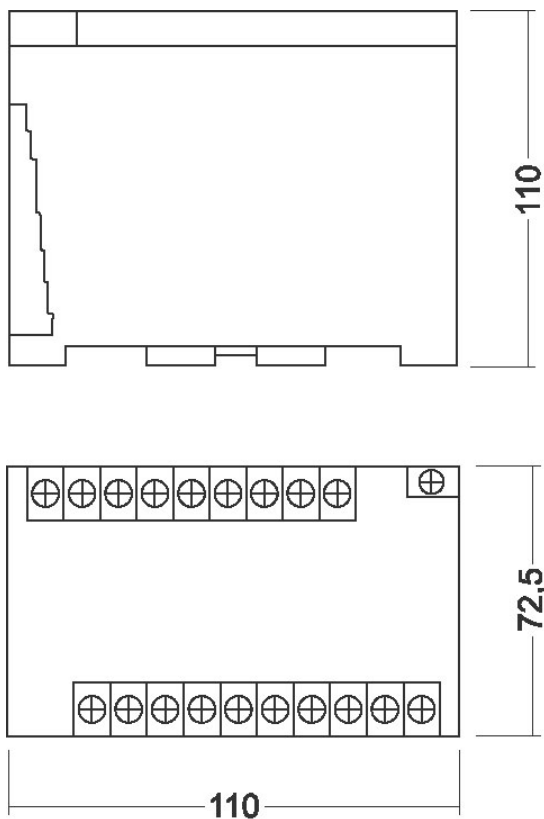

Connections

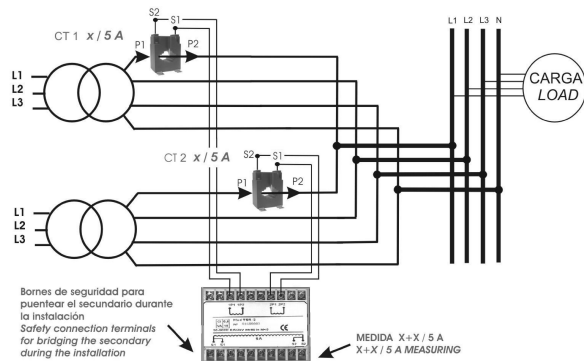

MODELO	ENTRADAS	POTENCIA	CODIGO
TSR-2	2	15VA. CI 0,5	M70701
TSR-3	3	15VA. CI 0,5	M70702
TSR-4	4	15VA. CI 0,5	M70703
TSR-5	5	15VA. CI 0,5	M70704

TSR