

## TCH12 2500/5A

TCH12 2500/5A, Current transformers high accuracy and narrow section

Code: M70486.

- > Flat strip(mm): 100 x 50
- > System: Single-phase
- > Class 0,2 Power (VA): 20
- > Class 0,2S Power (VA): 15
- > Class 0,5S Power (VA): 20
- > Measurement Range (A): 2500/5
- > Input current: 2500 A
- > Transformer type: Closed core

### Description

- Type: bar entrance
- Types: from 40 to 4000 A
- Internal diameter: from 20.3 to 63 mm, depending on the type
- Busbar dimensions: from 25 x 5 mm to 30 x 100 mm
- Transformer certificate sheet is attached
- Accessory on request for fixing on DIN rail (Types **TCH6** and **TCH6.2**)
- Secondary coding types .../5 A (on demand .../1 A.)

### Application

Converting a high nominal current to a lower current so that it can be measured by the unit. In installations where the electrical supply can be interrupted to install transformers and a high accuracy is required.



## TCH12 2500/5A

Current transformers narrow section and high accuracy

Code: M70486.

### Specifications

#### Electrical characteristics

Safety factor (SF)	FS 5
Power	20 VA (Class 0,2)

#### Mechanical characteristics

Size (mm) width x height x depth	129 x 155 x 78 (mm)
Envelope	Plastic wrap V0 self-extinguishing, UL 94
Weight (kg)	1,04

#### Environmental characteristics

Thermal Class	Class B (+130 °C)
Protection class	IP 20
Relative humidity (without condensation)	15 ... 95 %

#### Specific technical characteristics of current sensors

Operating voltage	0,72 kV~ max.
-------------------	---------------

#### Current measurement circuit

Nominal frequency	50 / 60 Hz
Primary current measurement	2500 A
Dynamic current (Idyn)	2,5 Ith
Thermal short-circuit current (Ith)	60 In
Transformation ratio	... / 5 A

#### Standards

Standards	IEC 44-1, BS2627
-----------	------------------

#### TCH

Current transformers narrow section and high accuracy

CODE	TYPE	Measurement Range (A)	Flat strip(mm)	Class 0,2 Power (VA)	Class 0,2S Power (VA)	Class 0,5S Power (VA)
<b>TCH6</b>						
M70431.	TCH6 150/5A	150/5	30 x 15  20 x 10  40 x 10	1,25	1	1,5
M70432.	TCH6 200/5A	200/5	30 x 15  20 x 10  40 x 10	1,5	1,25	2
M70433.	TCH6 250/5A	250/5	30 x 15  20 x 10  40 x 10	1,75	1,5	2,25
M70434.	TCH6 300/5A	300/5	30 x 15  20 x 10  40 x 10	2	1,75	2,5
M70435.	TCH6 400/5A	400/5	30 x 15  20 x 10  40 x 10	5	1	5



## TCH12 2500/5A

Current transformers narrow section and high accuracy

Code: M70486.

CODE	TYPE	Measurement Range (A)	Flat strip(mm)	Class 0,2 Power (VA)	Class 0,2S Power (VA)	Class 0,5S Power (VA)
M70436.	TCH6 500/5A	500/5	30 x 15  20 x 10  40 x 10	7,5	5	7,5
M70437.	TCH6 600/5A	600/5	30 x 15  20 x 10  40 x 10	7,5	5	7,5
M70438.	TCH6 750/5A	750/5	30 x 15  20 x 10  40 x 10	10	7,5	10
M70439.	TCH6 800/5A	800/5	30 x 15  20 x 10  40 x 10	10	7,5	10
<b>TCH6.2</b>						
M70441.	TCH6.2 100/5A	100/5	20 x 20  25 x 12  30 x 10	1,5	1	2,5
M70442.	TCH6.2 125/5A	125/5	20 x 20  25 x 12  30 x 10	1,5	1	2,5
M70443.	TCH6.2 150/5A	150/5	20 x 20  25 x 12  30 x 10	3,5	2,5	3,5
M70444.	TCH6.2 200/5A	200/5	20 x 20  25 x 12  30 x 10	5	3,5	5
M70445.	TCH6.2 250/5A	250/5	20 x 20  25 x 12  30 x 10	5	5	5
M70446.	TCH6.2 300/5A	300/5	20 x 20  25 x 12  30 x 10	5	5	5
M70447.	TCH6.2 400/5A	400/5	20 x 20  25 x 12  30 x 10	7,5	7,5	7,5
M7044B.	TCH6.2 50/5A	50/5	20 x 20  25 x 12  30 x 10	0,5		
M7044C.	TCH6.2 60/5A	60/5	20 x 20  25 x 12  30 x 10	0,5		
<b>TCH8</b>						
M70463.	TCH8 600/5A	600/5	50 x 30  60 x 12	10	5	10
M70464.	TCH8 750/5A	750/5	50 x 30  60 x 12	10	7,5	10
M70465.	TCH8 800/5A	800/5	50 x 30  60 x 12	10	7,5	10
M70466.	TCH8 1000/5A	1000/5	50 x 30  60 x 12	15	10	15
M70467.	TCH8 1200/5A	1200/5	50 x 30  60 x 12	15	10	15
M70468.	TCH8 1500/5A	1500/5	50 x 30  60 x 12	15	10	15
M70469.	TCH8 1600/5A	1600/5	50 x 30  60 x 12	15	10	15
M7046A.	TCH8 1250/5A	1250/5	50 x 30  60 x 12	15	10	15
<b>TCH10</b>						
M70472.	TCH10 800/5A	800/5	50 x 50  60 x 30  80 x 30	10	7,5	10
M70473.	TCH10 1000/5A	1000/5	50 x 50  60 x 30  80 x 30	10	7,5	10
M70474.	TCH10 1200/5A	1200/5	50 x 50  60 x 30  80 x 30	10	10	10
M70475.	TCH10 1500/5A	1500/5	50 x 50  60 x 30  80 x 30	10	10	15
M70476.	TCH10 1600/5A	1600/5	50 x 50  60 x 30  80 x 30	10	10	15
M70477.	TCH10 2000/5A	2000/5	50 x 50  60 x 30  80 x 30	10	10	15
M70478.	TCH10 2500/5A	2500/5	50 x 50  60 x 30  80 x 30	10	10	15
M70479.	TCH10 3000/5A	3000/5	50 x 50  60 x 30  80 x 30	10	10	15
M7047C.	TCH10 1250/5A	1250/5	50 x 50  60 x 30  80 x 30	10	10	10
<b>TCH12</b>						
M70482.	TCH12 1200/5A	1200/5	100 x 50	15	10	15
M70483.	TCH12 1500/5A	1500/5	100 x 50	15	10	15
M70484.	TCH12 1600/5A	1600/5	100 x 50	15	10	15
M70485.	TCH12 2000/5A	2000/5	100 x 50	15	10	15



## TCH12 2500/5A

Current transformers narrow section and high accuracy

Code: M70486.

CODE	TYPE	Measurement Range (A)	Flat strip(mm)	Class 0,2 Power (VA)	Class 0,2S Power (VA)	Class 0,5S Power (VA)
M70486.	TCH12 2500/5A	2500/5	100 x 50	20	15	20
M70487.	TCH12 3000/5A	3000/5	100 x 50	25	20	25
M70488.	TCH12 4000/5A	4000/5	100 x 50	30	25	30
M7048B.	TCH12 3200/5A	3200/5	100 x 50	25	20	25
M7048C.	TCH12 1250/5A	1250/5	100 x 50	15	10	15

For other configurations see table of additional features



## TCH12 2500/5A

Current transformers narrow section and high accuracy

Code: M70486.

### Dimensions

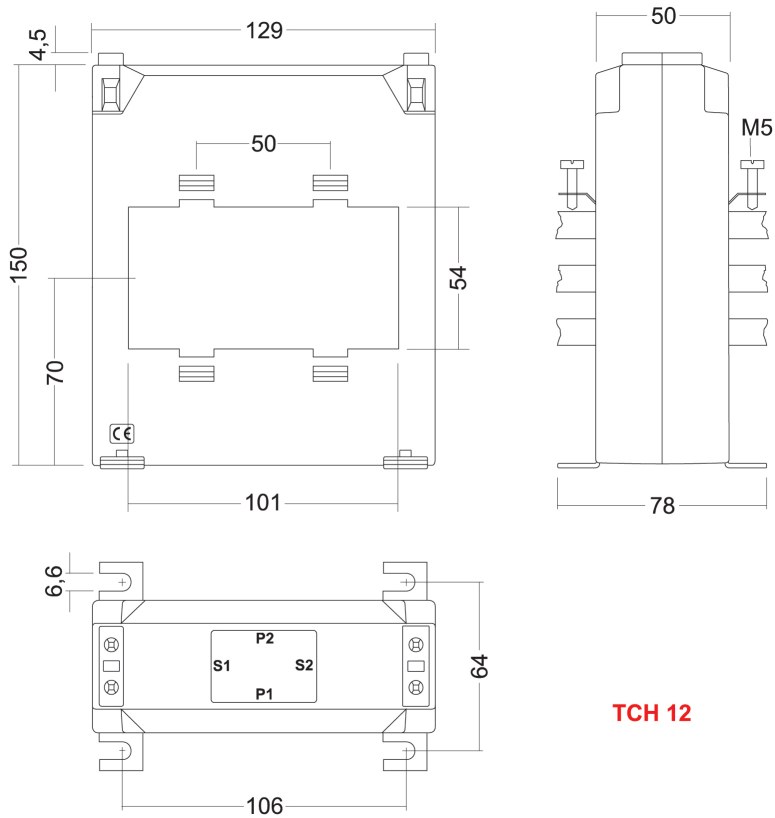

**TCH 12**