



TCH6.2 300/5A

TCH6.2 300/5A, Current transformers high accuracy and narrow section

Code: M70446. [CONSULTAR DISPONIBILIDAD](#)

- > Flat strip(mm): 20 x 20 | 25 x 12 | 30 x 10
- > System: Single-phase
- > Class 0,2 Power (VA): 5
- > Class 0,2S Power (VA): 5
- > Class 0,5S Power (VA): 5
- > Measurement Range (A): 300/5
- > Input current: 300 A
- > Transformer type: Closed core

Description

- Type: bar entrance
- Types: from 40 to 4000 A
- Internal diameter: from 20.3 to 63 mm, depending on the type
- Busbar dimensions: from 25 x 5 mm to 30 x 100 mm
- Transformer certificate sheet is attached
- Accessory on request for fixing on DIN rail (Types **TCH6** and **TCH6.2**)
- Secondary coding types .../5 A (on demand .../1 A.)

Application

Converting a high nominal current to a lower current so that it can be measured by the unit. In installations where the electrical supply can be interrupted to install transformers and a high accuracy is required.



TCH6.2 300/5A

Current transformers narrow section and high accuracy

Code: M70446.

Specifications

Electrical characteristics

Safety factor (SF)	FS 5
Power	5 VA (Class 0,2)

Mechanical characteristics

Size (mm) width x height x depth	81 x 87.22 x 71.19 (mm)
Envelope	Plastic wrap V0 self-extinguishing, UL 94
Weight (kg)	0,36

Environmental characteristics

Thermal Class	Class B (+130 °C)
Protection class	IP 20
Relative humidity (without condensation)	15 ... 95 %

Specific technical characteristics of current sensors

Inner diameter \varnothing (mm)	26
Operating voltage	0,72 kV~ max.

Current measurement circuit

Nominal frequency	50 / 60 Hz
Primary current measurement	300 A
Dynamic current (I _{dyn})	2,5 I _{th}
Thermal short-circuit current (I _{th})	60 I _n
Transformation ratio	... / 5 A

Standards

Standards	IEC 44-1, BS2627
-----------	------------------

For other configurations see table of additional features



TCH6.2 300/5A

Current transformers narrow section and high accuracy

Code: M70446.

Dimensions

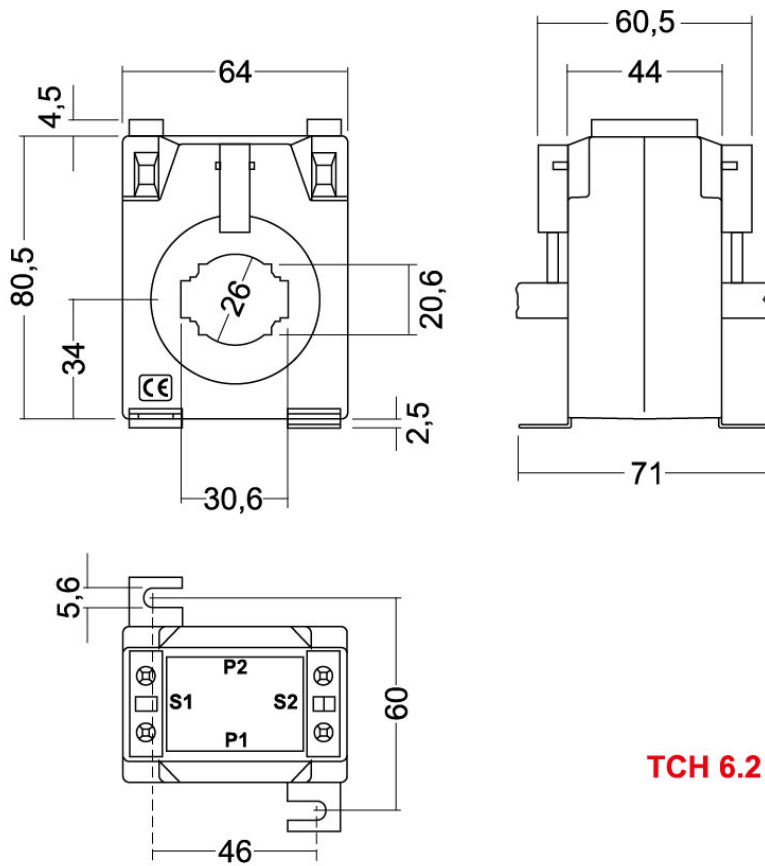

TCH 6.2

