



CC-A Out1

CC-A Out1, Transducer Aac

Code: M25131.

- > Output type: 1
- > Analog output: 0...20mA
- > Measure: 5 Aac
- > Paramètre: A ~

Description

CC-A transducers, convert A.C current to D.C process indicator signal.

The analog output is directly proportional to the input signal, calibrated as a RMS with sinus signal of 50 Hz.



CC-A Out1

AC Current transducer

Code: M25131.

Specifications

AC power supply, insulation

Pulse test (kV)	4 kV (1,2/50µs)
Test voltage (kV)	3 kV RMS 50 Hz 1min

AC power supply

Consumption	2,5 VA
Frequency	40...90 Hz
Nominal voltage	115/230/400 Vca (-15...+20 %)

Mechanical characteristics

Size (mm) width x height x depth	45 x 75 x 110 (mm)
Weight (kg)	0,26

Environmental characteristics

Protection class	IP 20 (Terminals) IP 40 (case)
Storage temperature	-40...+70 °C
Working temperature	-10...+55 °C

Current measurement circuit

Consumption	0,2 VA
Nominal current (In)	1 A / 5 A
Phase current measurement	0...150 % In
Allowable overload	300 % In permanent

Voltage measurement circuit

Frequency measuring range	45...65 Hz
---------------------------	------------

Standards

Electrical safety, Maximum height (m)	2000
Standards	IEC 529, IEC 688, IEC 801, EN 50081-2, EN 50082-2, IEC 1010

Analogue inputs

Load impedance in current	< 500 Ω
Ripple (effective RMS value)	< 0,5 %
Load impedance in voltage	> 500 Ω
Response time	< 300 ms (0...99 % Vn)

Analogue outputs

Current mode, nominal range	0...20 mA
-----------------------------	-----------



CC-A Out1

AC Current transducer

Code: M25131.

Displaced output	0,2...2 V / 2...10 V / 4...20 mA
Voltage mode: nominal output range	0...5, 10 Vac

Measurement accuracy

Phase current measurement	0,2 % FS
---------------------------	----------

CC-A

AC Current transducer

CODE	TYPE	Output type	Analog output	Measure	Paramètre
AC Current. Accuracy: $\pm 0,2$ % reading, 40...90 Hz					
M25131.	CC-A Out1	1	0...20mA	5 Aac	A ~
M25132.	CC-A Out2	2	4...20mA	5 Aac	A ~

-AP type: Accuracy: $\pm 0,5$ % reading, 40...90 Hz. External auxiliary supply not required. Specify: Zero value, full scale and output type.
For other values, see coding table on following pages



CC-A Out1

AC Current transducer

Code: M25131.

Dimensions

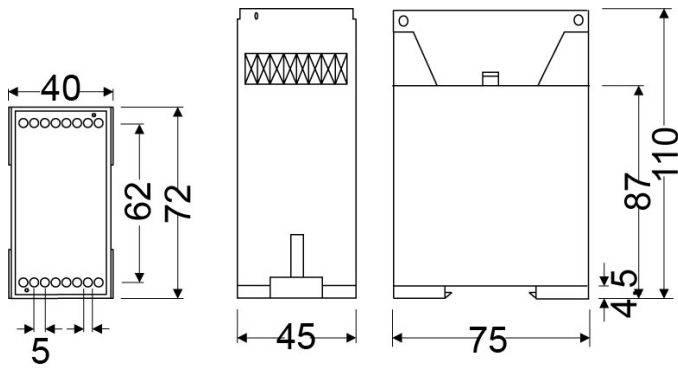

Connections

