



PIC144A 230 V

PIC144A 230 V, Phasemeter

Code: M13642. DESCATALOGADO

- > Scale: 360°, P1
- > System: Single-phase
- > Accuracy: 1,5
- > Measurement Range (V): 230
- > Modules: 144x144

Description

- Does not need an auxiliary power supply
- DIN box with dimensions 96 and 144.
- Class 1,5
- Balanced and unbalanced single and three-phase circuits.
- 4 quadrants

Application

Measurement of $\cos\phi$ in balanced or unbalanced single and three-phase circuits.



PIC144A 230 V

Phasemeters

Code: M13642.

Specifications

Mechanical characteristics

Size (mm) width x height x depth	144 x 144 x 102 (mm)
Fastening	Panel
Weight (kg)	1,96

Environmental characteristics

Protection class	Panel: IP 52 (Front), IP 00 (Terminals)
Storage temperature	-25...+40 °C
Working temperature	+10 ... +30 °C

Standards

Certifications	CE, UL
Electrical safety, Maximum height (m)	2000
Standards	BS 89, UNE-EN 60051, IEC 144, UL 94, DIN 43780, IEC 51, UNE 21318

Current measurement circuit

Consumption	4 VA
Sampling frequency	20 ... 100 Hz
Nominal current (In)	... 5 A
Allowable overload	1,2 In permanent / 5 In during 30s / 10 In during 5s / 40 In during 1s

Voltage measurement circuit

Consumption	5 VA
Sampling frequency	49,5 ... 50,5 Hz / 59,4 ... 60,6 Hz

Electrical characteristics

Insulation voltage, circuit	2 kV a 50 Hz <1 min entre mecanismo y caja
-----------------------------	--

Measurement accuracy

Accuracy	± 1,5 % FE
----------	------------

Current range: 0.1 to 1.2 In. For the connection of transformers .../5A.



PIC144A 230 V

Phasemeters

Code: M13642.

Dimensions

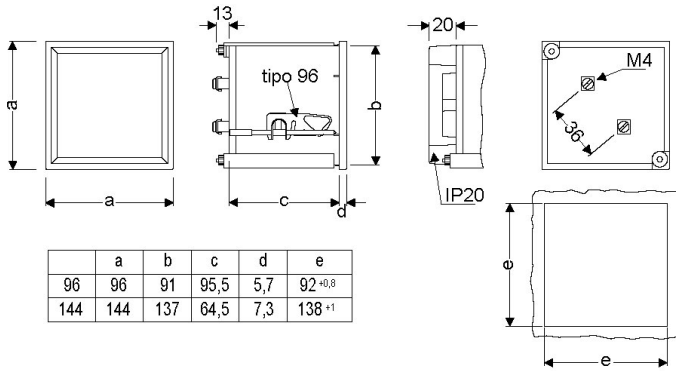

Connections

