



FMZ96 500V

FMZ96 500V, Phasemeter

Code: M13538. (CONSULTAR DISPONIBILIDAD)

- > Scale: 240° P1
- > System: Single-phase
- > Accuracy: 1,5
- > Measurement Range (V): 500
- > Modules: 96x96

Description

- Does not need an auxiliary power supply
- DIN box with dimensions 96 and 144 mm.
- Precision class 1,5
- Built-in electronic converter
- Balanced single and three-phase circuits

Application

Measurement of $\cos\phi$ in balanced or unbalanced single and three-phase circuits



FMZ96 500V

Phasemeters

Code: M13538.

Specifications

Mechanical characteristics

Size (mm) width x height x depth	96 x 96 x 101.2 (mm)
Weight (kg)	0,5

Environmental characteristics

Protection class	Panel: IP 52 (Front), IP 00 (Terminals)
Storage temperature	-25...+40 °C
Working temperature	+10 ... +30 °C

Standards

Certifications	UL
Electrical safety, Maximum height (m)	2000
Standards	BS 89, UNE-EN 60051, IEC 144, UL94, DIN 43780, IEC 51, UNE 21318

Current measurement circuit

Consumption	0,75 VA
Sampling frequency	20 ... 100 Hz
Nominal current (In)	... 5 A
Allowable overload	1,2 In permanent / 5 In during 30s / 10 In during 5s / 40 In during 1s

Voltage measurement circuit

Consumption	4 VA
Sampling frequency	40 ... 70 Hz
Maximum permanent measurement voltage	1,2 Vn permanent rated voltage / 2 Vn during 5s

Electrical characteristics

Insulation voltage, circuit	2 kV, 50 Hz, 1 min entre mecanismo y caja
-----------------------------	---

Measurement accuracy

Accuracy	± 1,5 % FE
----------	------------

Current range: 0.1 to 1.2 In. For the connection of transformers .../5A. Built-in electronic transducer.



FMZ96 500V

Phasemeters

Code: M13538.

Dimensions

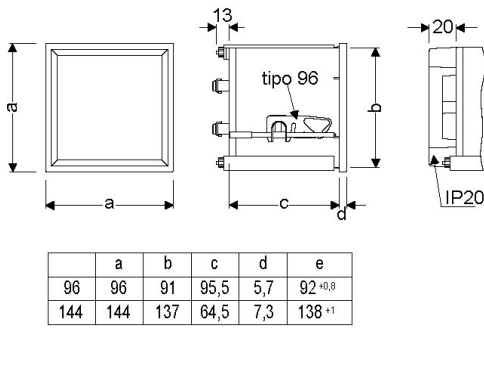

	a	b	c	d	e
96	96	91	95,5	5,7	92 ^{+0,8}
144	144	137	64,5	7,3	138 ⁺¹

Connections

