



FEMC96 230V

FEMC96 230V, Phasemeter

Code: M13435.

- > Scale: 90° P1
- > System: Single-phase
- > Accuracy: 1,5
- > Measurement Range (V): 230
- > Modules: 96x96

Description

- Does not need an auxiliary power supply
- DIN box with dimensions 96 and 144 mm
- Class 1,5
- Built-in electronic converter
- Balanced single and three-phase circuits

Application

Measurement of $\cos\varphi$ in balanced or unbalanced single and three-phase circuits.



FEMC96 230V

Phasemeters

Code: M13435.

Specifications

Mechanical characteristics

Size (mm) width x height x depth	96 x 96 x 62.9 (mm)
Weight (kg)	0,48

Environmental characteristics

Protection class	Panel: IP 52 (Front), IP 00 (Terminals)
Storage temperature	-25...+40 °C
Working temperature	+10 ... +30 °C

Standards

Certifications	UL
Electrical safety, Maximum height (m)	2000
Standards	BS 89, UNE-EN 60051, IEC 144, UL94, DIN 43780, IEC 51, UNE 21318

Current measurement circuit

Consumption	1,5 VA
Nominal current (In)	... 5 A
Allowable overload	1,2 In permanent / 5 In during 30s / 10 In during 5s / 40 In during 1s

Voltage measurement circuit

Consumption	1 VA
Sampling frequency	40 ... 70 Hz
Maximum permanent measurement voltage	1,2 Vn permanent rated voltage / 2 Vn during 5s

Electrical characteristics

Insulation voltage, circuit	2 kV, 50 Hz, 1 min entre mecanismo y caja
-----------------------------	---

Measurement accuracy

Accuracy	± 1,5 % FE
----------	------------



FEMC96 230V

Phasemeters

Code: M13435.

FEMC / FETC

Single phase and three-phase 90° electronic phase-meters

CODE	TYPE	Scale	Accuracy	Modules
M13431.	FEMC96 100/ $\sqrt{3}$ V	90° P1	1,5	96x96
M13432.	FEMC96 110/ $\sqrt{3}$ V	90° P1	1,5	96x96
M13433.	FEMC96 100V	90° P1	1,5	96x96
M13434.	FEMC96 110V	90° P1	1,5	96x96
M13435.	FEMC96 230V	90° P1	1,5	96x96
M13436.	FEMC96 400V	90° P1	1,5	96x96
M13437.	FEMC96 440V	90° P1	1,5	96x96
M13438.	FEMC96 500V	90° P1	1,5	96x96
M13441.	FEMC144 100/ $\sqrt{3}$ V	90° P1	1,5	144x144
M13442.	FEMC144 110/ $\sqrt{3}$ V	90° P1	1,5	144x144
M13443.	FEMC144 100V	90° P1	1,5	144x144
M13444.	FEMC144 110V	90° P1	1,5	144x144
M13445.	FEMC144 230V	90° P1	1,5	144x144
M13446.	FEMC144 400V	90° P1	1,5	144x144
M13447.	FEMC144 440V	90° P1	1,5	144x144
M13448.	FEMC144 500V	90° P1	1,5	144x144
M1343C.	FETC96 100V	90° P1	1,5	96x96
M1343D.	FETC96 110V	90° P1	1,5	96x96
M1343E.	FETC96 230V	90° P1	1,5	96x96
M1343F.	FETC96 400V	90° P1	1,5	96x96
M1343G.	FETC96 440V	90° P1	1,5	96x96
M1343H.	FETC96 500V	90° P1	1,5	96x96
M1344C.	FETC144 100V	90° P1	1,5	144x144
M1344D.	FETC144 110V	90° P1	1,5	144x144
M1344E.	FETC144 230V	90° P1	1,5	144x144
M1344F.	FETC144 400V	90° P1	1,5	144x144
M1344G.	FETC144 440V	90° P1	1,5	144x144
M1344H.	FETC144 500V	90° P1	1,5	144x144

Current range: 0.1 to 1.2 In. For the connection of transformers .../5A. Built-in electronic transducer.



FEMC96 230V

Phasemeters

Code: M13435.

Dimensions

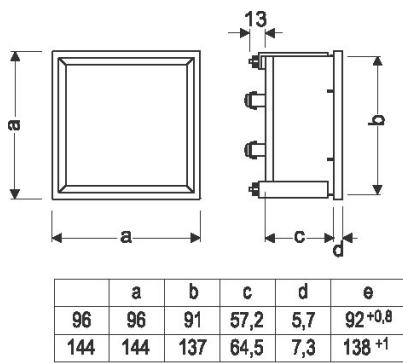

Connections

