



YTC96AN 400V .../5A

YTC96AN 400V .../5A, Vattmeter

Code: M13233. DESCATALOGADO

- > Scale: 90° P1
- > System: Three-phase 4 wire
- > Accuracy: 1,5
- > Measure: 400 Vph-ph, .../5 A
- > Device: YTC96AN
- > Modules: 96x96

Description

- Does not need an auxiliary power supply
- DIN box with dimensions 96 and 144.
- Class 1.5
- Built-in electronic converter
- Balanced and unbalanced single and three-phase circuits.

Application

Measurement of the power factor in balanced or unbalanced single and three-phase circuits.



YTC96AN 400V .../5A

Wattmeters and varimeters

Code: M13233.

Specifications

Mechanical characteristics

Size (mm) width x height x depth	96 x 96 x 62.9 (mm)
Fastening	Panel
Weight (kg)	0,43

YMC / YTC

Single-phase and three-phase varimeters

CODE	TYPE	Scale	Accuracy	Modules	Device	Measure
Balanced three-phase						
M13232.	YTC96E 400V .../5A	90° P1	1,5	96x96	YTC96E	400 Vph-ph, .../5 A

Exchangeable scales for types YMC 96, YTC 96E and YTC 96A. Scale not included (*1) Specify primary voltage and current of the measuring transformers, and power at full scale



YTC96AN 400V .../5A

Wattmeters and varmeters

Code: M13233.

Dimensions

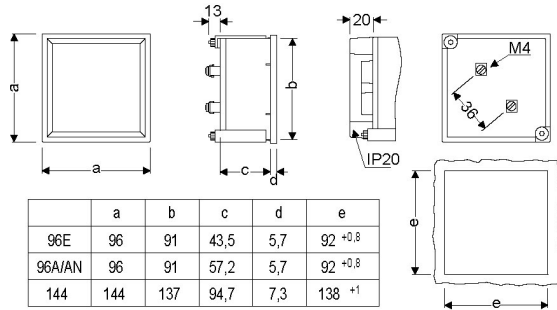

Connections

