



WMC96 400V .../5A

WMC96 400V .../5A, Vattmeter

Code: M13031.

- > Scale: 90° P1
- > System: Single-phase
- > Accuracy: 1,5
- > Measure: 400 Vph-ph, .../5 A
- > Device: WMC96
- > Modules: 96x96

Description

- Does not need an auxiliary power supply
- DIN box with dimensions 96 and 144.
- Class 1.5
- Built-in electronic converter
- Balanced and unbalanced single and three-phase circuits.

Application

Measurement of active power in balanced or unbalanced single and three-phase circuits.



WMC96 400V .../5A

Wattmeters and varmeters

Code: M13031.

Specifications

Mechanical characteristics

Size (mm) width x height x depth	96 x 96 x 49.2 (mm)
Fastening	Panel
Weight (kg)	0,21

WMC / WTC

Single-phase and three-phase wattmeters

CODE	TYPE	Scale	Accuracy	Modules	Device	Measure
Single-phase						
M13031.	WMC96 400V .../5A	90° P1	1,5	96x96	WMC96	400 Vph-ph, .../5 A
M13041.	WMC144 400V .../5A	90° P1	1,5	96x96	WMC144	400 Vph-ph, .../5 A
Balanced three-phase						
M13032.	WTC96E 400V .../5A	90° P1	1,5	96x96	WTC96	400 Vph-ph, .../5 A
Three-phase 3 wire (ARON)						
M13034.	WTC96A 110V .../5A	90° P1	1,5	96x96	WTC96A	110 Vph-ph, .../5A
Three-phase 4 wire						
M13033.	WTC96AN 400V .../5A	90° P1	1,5	96x96	WTC96AN	400 Vph-ph, .../5 A

Exchangeable scales for types WMC 96, WTC 96E and WTC 96AN. Scale not included (*) Specify primary voltage and current of the measuring transformers, and power at full scale



WMC96 400V .../5A

Wattmeters and varmeters

Code: M13031.

Dimensions

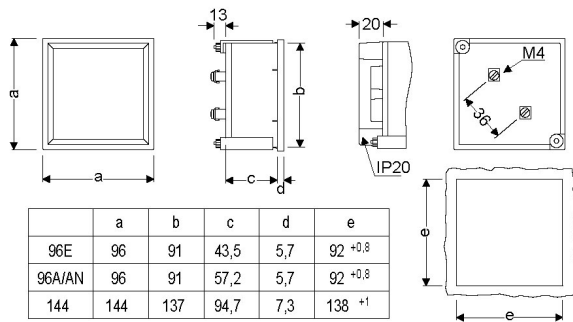

Connections

