



EZC96 500V

EZC96 500V, Voltmeter

Code: M11138. DESCATALOGADO

- > Scale: 240°, P1
- > Accuracy: 5
- > Measurement Range (V): 500
- > Device: EZC96
- > Modules: 96x96

Specifications

Mechanical characteristics

Size (mm) width x height x depth	96 x 96 x 49.2 (mm)
Fastening	Panel
Weight (kg)	0,22

Environmental characteristics

Protection class	Panel: IP 52 (Front), IP 00 (Terminals)
Storage temperature	-25...+40 °C
Working temperature	+10 ... +30 °C

Standards

Certifications	CE
Electrical safety, Maximum height (m)	2000
Standards	BS 89, UNE-EN 60051, IEC 144, DIN 43780, IEC 51, UNE 21318

Voltage measurement circuit

Consumption	1 ... 4 VA
Sampling frequency	20 ... 100 Hz
Maximum permanent measurement voltage	1,5 Vn permanent rated voltage / 2 Vn during 5s

Electrical characteristics

Insulation voltage, circuit	2 kV, 50 Hz, 1 min entre mecanismo y caja
-----------------------------	---

Measurement accuracy

Accuracy	5 % FE
----------	--------



EZC96 500V

Code: M11138.

Dimensions

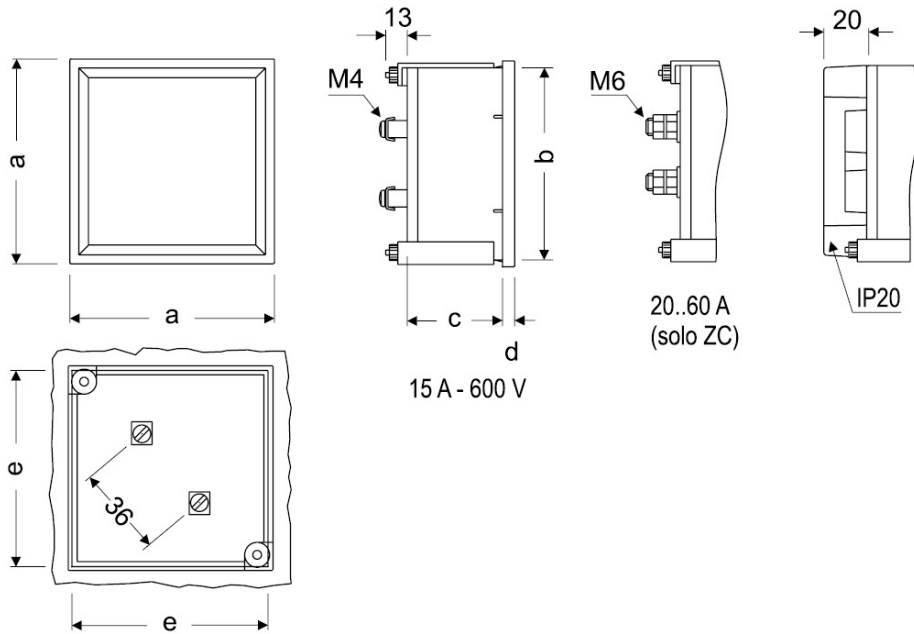

Type	Fig. ZC	Fig. EZC	a	b	c	d	e
48	1	-	48	44,7	61	5,2	45
72	1	1	72	67,2	43,5	5,7	68
96	1	1	96	91	43,5	5,7	92
144	1	-	144	137	64,5	7,3	138