



EMSC45 30A

EMSC45 30A, Ammeter

Code: M10267.

- > Scale: 90°, P2
- > Accuracy: 1,5
- > Measurement Range (A): 30

Description

- No need for auxiliary power supply
- Measurement in true root mean square 100 mA . 100 A
- Exchangeable scales

Application

In alternating current applications, to control the state of the current quickly and visually.



EMSC45 30A

Moving Iron Milliammeters and Ammeter

Code: M10267.

Specifications

Mechanical characteristics

Size (mm) width x height x depth	85 x 52 x 65 (mm)
Weight (kg)	0,11

Environmental characteristics

Protection class	DIN rail: IP 52 (front), IP 00 (terminals)
Storage temperature	-25...+40 °C
Working temperature	+10 ... +30 °C

Standards

Certifications	CE, UL
Electrical safety, Maximum height (m)	2000
Standards	BS 89, UNE-EN 60051, IEC 144, UL94, DIN 43780, IEC 51, UNE 21318

Current measurement circuit

Consumption	0,3 ... 1,5 VA
Sampling frequency	20...100 Hz
Allowable overload	1,2 In permanent / 5 In during 30s / 10 In during 5s / 40 In during 1s

Electrical characteristics

Insulation voltage, circuit	2 KV, 50 HZ <1 min entre mecanismo y caja
-----------------------------	---

Measurement accuracy

Accuracy	1,5 % FE
----------	----------

EMSC-A

Moving Iron Ammeter

CODE	TYPE	Scale	Accuracy	Measurement Range (A)
M10262.	EMSC45 5A	90°, P2	1,5	5
M10263.	EMSC45 10A	90°, P2	1,5	10
M10264.	EMSC45 15A	90°, P2	1,5	15
M10265.	EMSC45 20A	90°, P2	1,5	20
M10266.	EMSC45 25A	90°, P2	1,5	25
M10267.	EMSC45 30A	90°, P2	1,5	30
M10268.	EMSC45 40A	90°, P2	1,5	40
M10269.	EMSC45 50A	90°, P2	1,5	50
M1026A.	EMSC45 60A	90°, P2	1,5	60



EMSC45 30A

Moving Iron Miliammeters and Ammeter

Code: M10267.

CODE	TYPE	Scale	Accuracy	Measurement Range (A)
M10260.	EMSC45 ... /5A	90°, P2	1,5	.../5 A

Exchangeable scales. See next page



EMSC45 30A

Moving Iron Milliampmeters and Ammeter

Code: M10267.

Dimensions

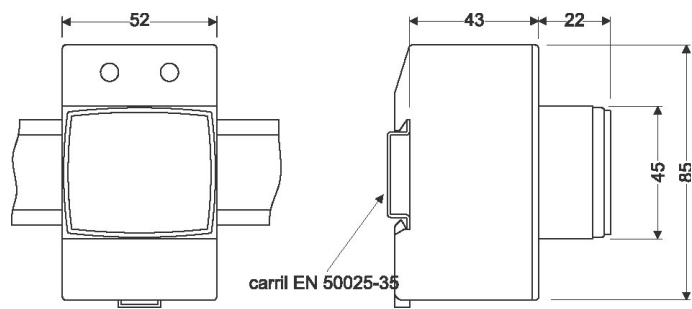

Connections

