



EMSC45 500mA

EMSC45 500mA, Ammeter

Code: M10167.

- > Scale: 90°, P2
- > Accuracy: 1,5
- > Measurement Range (A): 0,5

Description

- No auxiliary power needed
- Accuracy class 1.5
- True root mean square value of 100 mA... 600 mA
- Interchangeable scales

Application

Alternating current applications to quickly and visually monitor the status of the current.



EMSC45 500mA

Moving-iron ammeters (AC)

Code: M10167.

Specifications

Mechanical characteristics

Size (mm) width x height x depth	85 x 52 x 65 (mm)
Weight (kg)	0,14

Environmental characteristics

Protection class	DIN rail: IP 52 (front), IP 00 (terminals)
Storage temperature	-25...+40 °C
Working temperature	+10 ... +30 °C

Standards

Certifications	CE, UL
Electrical safety, Maximum height (m)	2000
Standards	BS 89, UNE-EN 60051, IEC 144, UL94, DIN 43780, IEC 51, UNE 21318

Current measurement circuit

Consumption	0,3 ... 1,5 VA
Sampling frequency	20...100 Hz
Allowable overload	1,2 In permanent / 5 In during 30s / 10 In during 5s / 40 In during 1s

Electrical characteristics

Insulation voltage, circuit	2 KV, 50 HZ <1 min entre mecanismo y caja
-----------------------------	---

Measurement accuracy

Accuracy	1,5 % FE
----------	----------

EMSC-mA

Moving Iron Milliammeters

CODE	TYPE	Scale	Accuracy	Measurement Range (A)
M10161.	EMSC45 100mA	90°, P2	1,5	0,1
M10162.	EMSC45 150mA	90°, P2	1,5	0,15
M10164.	EMSC45 250mA	90°, P2	1,5	0,25
M10165.	EMSC45 300mA	90°, P2	1,5	0,3
M10166.	EMSC45 400mA	90°, P2	1,5	0,4
M10167.	EMSC45 500mA	90°, P2	1,5	0,5
M10168.	EMSC45 600mA	90°, P2	1,5	0,6



EMSC45 500mA

Moving-iron ammeters (AC)

Code: M10167.

Dimensions

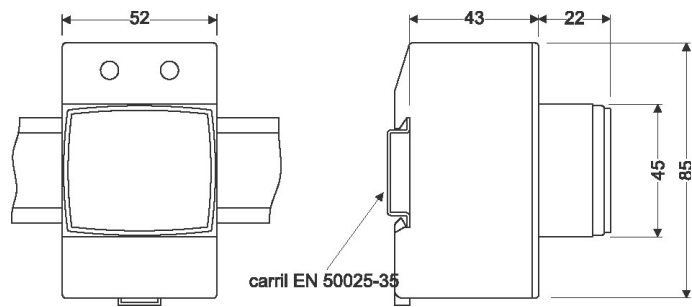

Connections

